

THIS COPY IS PROVIDED ON A RESTRICTED BASIS AND IS NOT TO BE USED IN ANY WAY DETRIMENTAL TO THE INTERESTS OF PANDUIT CORP.

Material	High Conductivity Seamless Copper Tube
Plating	Electro-Tin
Wire Size & Type	Stranded Copper Flex Cable; 373.7 kcmil (925/24) Diesel Locomotive, 350 kcmil Class K & Class M
Wire Strip Length	1-15/16 in.
Stud Size	3/4 in.
UL Listed Wire Connector	Yes, for applications up to 35kv. Consult cable manufacturer for voltage stress relief instructions with applications greater than 2000 volts.
UL Temperature Rating	90° C
C.S.A Certified Wire Connector	Yes
Panduit Color Code on Barrel	BLUE
Panduit Die Index No. on Barrel	P76
Alternate Industry Die Index No. () on Barrel	(19)

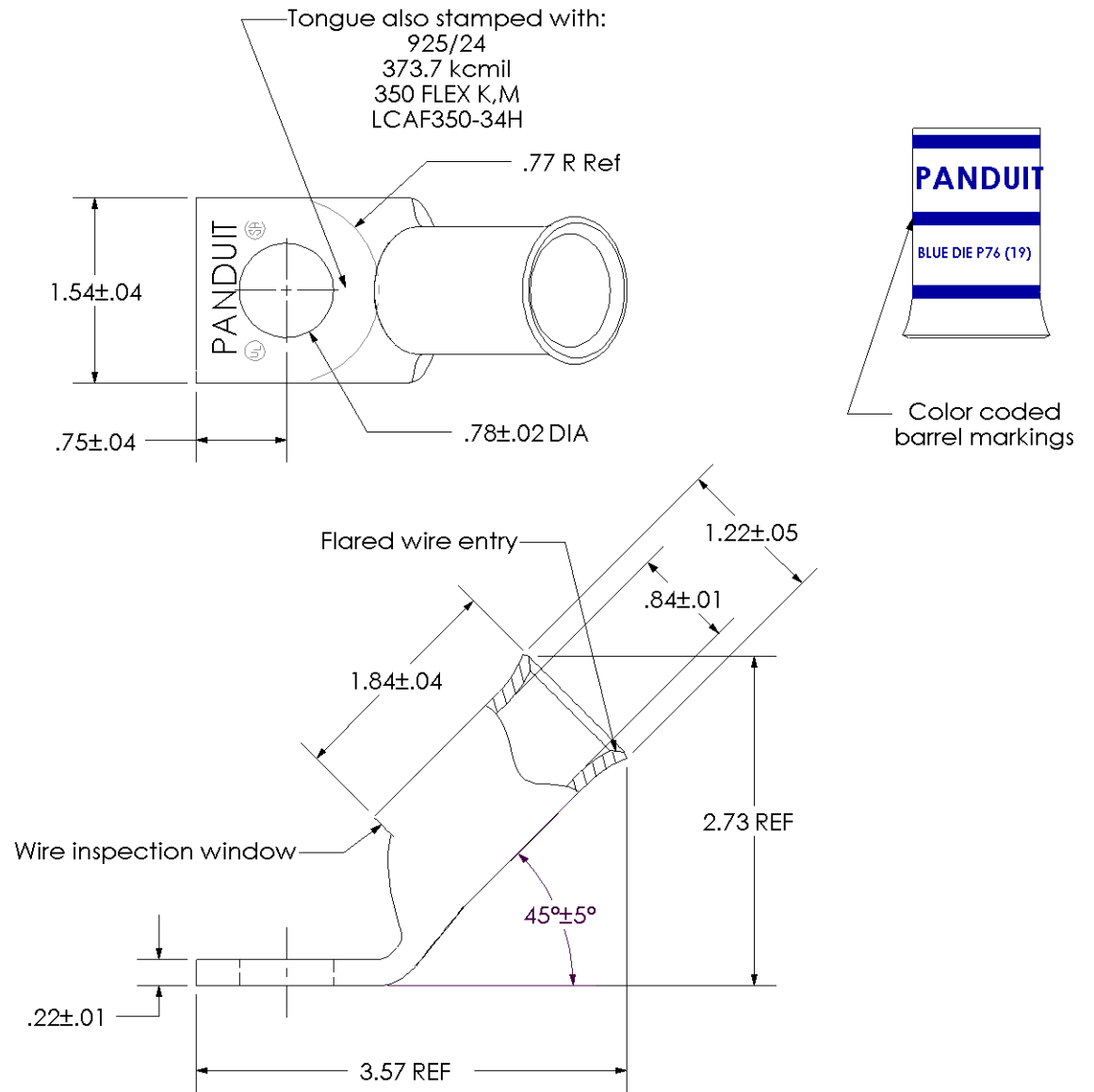

00	8/02	SAB	DRL	RELEASED	10322
REV	DATE	BY	CHK	DESCRIPTION	ECN

PANDUIT CORP. TINLEY PARK, ILLINOIS

LCAF350-34H-6
Copper Lug - One-Hole, Flared Barrel, 45° Angle Tongue

SCALE N/A DRAWING NO / CAD FILE LCAF350-34H-CUST